



X⁵ - Pack X-ray Inspection System

Designed for Food & Packaging Industries

Product Highlights

- The X⁵ Pack is designed to integrate into line with a built-in reject station and is available in 300mm, 500mm and 600mm belt width models
- Good detection of all metals, bone, glass and dense plastics, even in foil trays or metalized film
- Belt Speeds of up to 80m/Min with Pack Speeds of up to 200 P/Pmin (Based on a typical Ready Meal size)
- Fast inspection with the Set-up wizard automatically optimising the X⁵ Pack for each product type allowing you to learn and switch within minutes
- Reliable Heavy duty conveyor components, built for 24/7 operation with pass key Protective Set-up for added security and control
- Windows 10 PC with modem, Ethernet and Front Access USB Port



Versatile Detection with AAT Technology

AAT Technology allows 0.4mm Diode setting for very small metal contaminants, with the option of switching to 0.8mm & 1.6mm to find softer contaminants such as Bone, Ceramic and Glass.

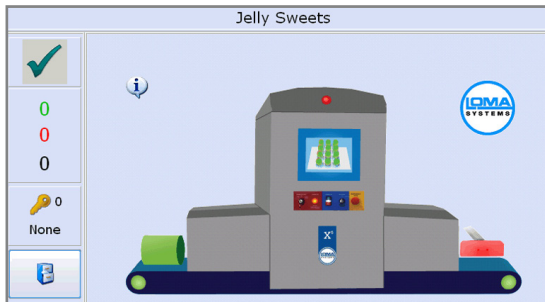

Easy to Use Intuitive Full Colour Touchscreen

The X⁵ Pack includes an Icon driven full colour touchscreen control interface including multi-level password access and data logged events for traceability (designed to comply with CFR21 Part 11 requirements)

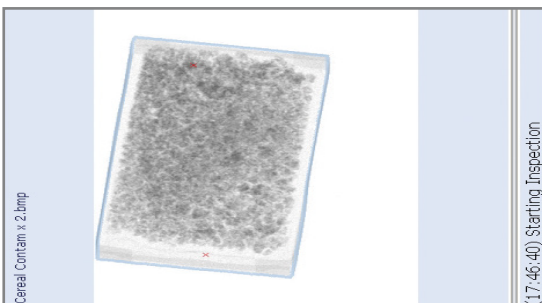

Data Logged Events and Images for Full Traceability

Date stamped reject images designed to comply with CFR21 Part 11 requirements are internally stored and can be removed via USB or Ethernet.

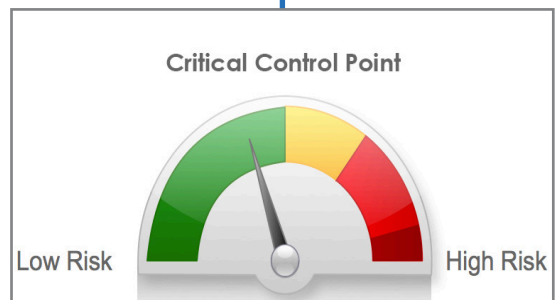

Fully Enclosed CCP Solution with Integrated Reject Station

All in one system with optional retail compliance offers complete control and removes risk.

Technical Specification

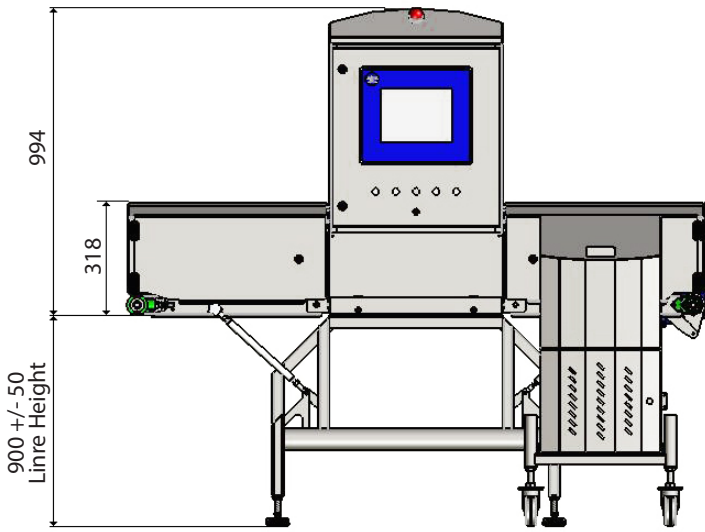
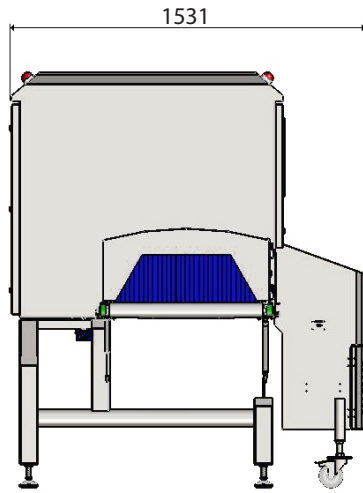

All dimensions in mm

Machine in picture is based on 600 Model

Finish	304 Brushed Stainless Steel
System Length	2000m
Line Height Option	700 - 1100mm +/- 50mm
X-Ray Output	150W (60kV 2.5mA)
IP Rating	IP66
Belt Width	300/500/600mm
Belt Type	PU Blue Belt
Max Product Weight	25kg
Speed Range	20-80 m/min
Power Requirements	230V AC, 50Hz or 110v AC 60Hz, Single Phase Mains
Cooling	Vortex or AC Air Conditioning
Operating Environment (Vortex Standard)	2 - 10°C with warm up 10 to 25°C Vortex
Operating Environment AC Air Conditioning (Option)	25°C to 35°C AC Air Conditioning (Cabinet reduced to NEMA 4X with AC Option)
X-Ray Safety	Leakage less than 1 µSv/h
Detection Algorithms	15 Multilayers Algorithms combined in any combinations
Reporting	Event, Batch, Shift, PVS
Data Retrieval	Via USB, Ethernet, Enet

Product Inspection Window Sizes

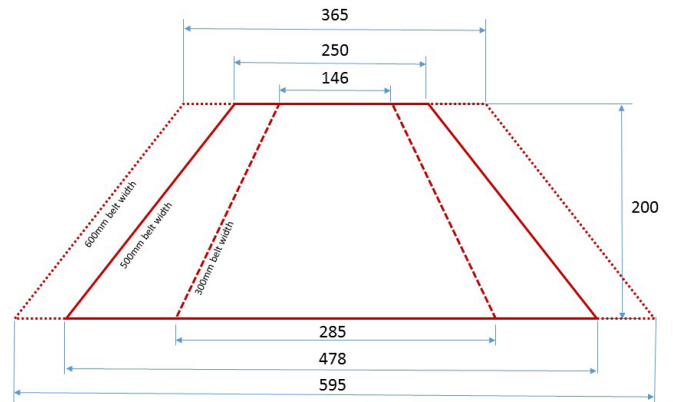

Included Automatic Reject Options

The X³ Pack is supplied as standard with one of the following options:

- Pusher
- Air-blast, single nozzle
- Air-blast, dual nozzle

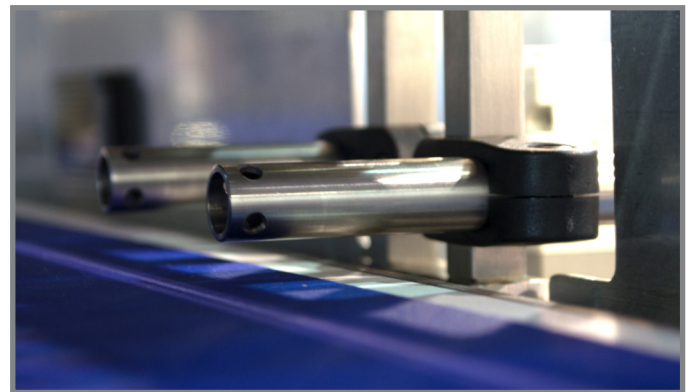

An ITW Company

Loma Systems is a registered trademark of Illinois Tool Works Inc. (ITW). Other names, logos, icons and marks identifying our products and services referenced herein are trademarks of ITW and may not be used without the prior written permission of ITW. Other product and company names listed are trademarks or trade names of their respective companies. Copyright © 2019 Illinois Tool Works Inc. All rights reserved. All of the specifications shown in this document are subject to change without notice.

www.loma.com
 Tel: +44(0)1252 893300 (UK) | +1-800-872-LOMA (North America)
Metal Detection | Checkweighing | X-Ray Inspection

In association with



XSPACKv2_B93201905